



# Application Note: SY6918

## High Efficiency Bi-Direction Power Bank Regulator For Single-Cell Battery Power bank

### General Description

SY6918 is a 5V adapter input with up to 18V surge bi-directional regulator designed for single cell Li-Ion battery power bank application. Advanced bi-directional energy flow control with automatic input power source detection is adopted to achieve battery charging mode and battery power supply mode alternately.

SY6918 also integrates the KEY control and LED status indication.

SY6918 is available in QFN3x3 package to minimize the PCB layout size for wide portable applications.

### Ordering Information

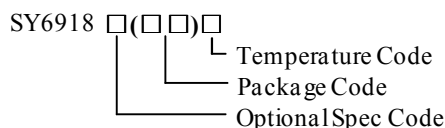

Ordering Number	Package type	Note
SY6918QDC	QFN3x3-16	

### Features

- Maximum 18V input voltage surge
- Bad adapter detection
- Build in power path NFETs and Power Switches
- 500kHz switching frequency operation
- Trickle Current / Constant Current / Constant Voltage Charge Mode with internal compensation
- Maximum 2A Constant Charge Current
- Maximum 2.5A Boost output current
- 4.2V/4.35V selectable battery cell voltage
- +/-0.5% cell voltage accuracy
- Charge/discharge/fault status indicator
- Key controls logic
- Boost auto start when portable device inserts
- Boost auto shutdown with light load
- Programmable input current limit
- Dynamic Power Management
- Cycle-by-Cycle peak current limitation
- Input Voltage UVLO and OVP
- Boost output Short Circuit Protection
- Thermal shutdown

### Applications

- 1-Cell Power Bank
- Portable Device with 1-Cell Battery

### Typical Applications

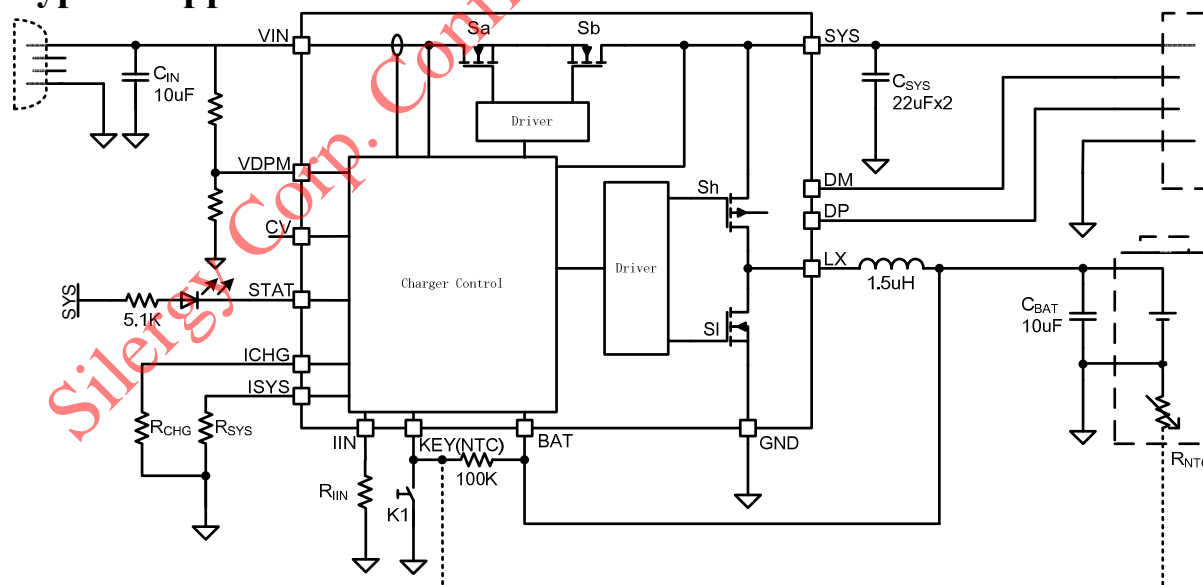
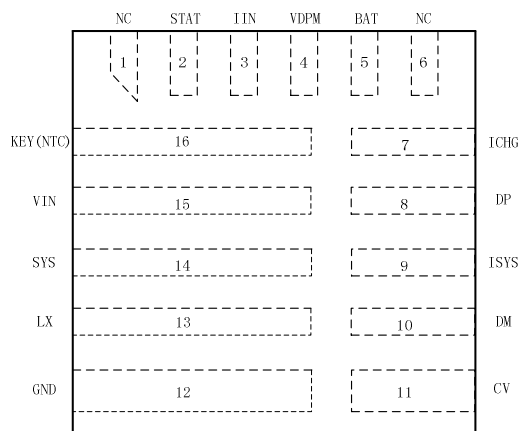

Figure 1. Schematic Diagram



# SY6918

## Pinout (top view)



(QFN3x3-16)

Top Mark: **BFL**xyz, (Device code: BFL, x=year code, y=week code, z=lot number code)

Name	No	Description
NC	1	Not connected.
STAT	2	Charge or discharge status indication pin. Open drain output. Pull high to SYS through a LED to indicate the charge or discharge in process. When the charge is done, LED is off. This LED is also used as fault indicator.
IIN	3	Connect a resistor to set the input current limit in Buck mode.
VDPM	4	Voltage sense for input dynamic management. If the voltage drops to the internal 1.2V reference voltage, the VIN will be clamped to the setting value.
BAT	5	Battery voltage sense pin. Used as battery constant voltage control and battery voltage protections.
NC	6	Not connected.
ICHG	7	Connect a resistor to set charge current limit in Buck mode.
DP	8	D+/D- output for USB port connection. It supports BC1.2 handshaking. And also supports Apple and Samsung portable device.
DM	10	
ISYS	9	Connect a resistor to set SYS current limit in boost mode.
CV	11	Charge voltage selection pin. Open or pull low for 4.2V. Pull high for 4.35V
GND	12	Power ground.
LX	13	Switch node pin. Connect to external inductor.
SYS	14	System connection point. Add at least 2pcs of 22uF MLCC here.
VIN	15	Power input pin. Connect a MLCC from this pin to ground to decouple high harmonic noise. This pin has OVP and UVLO function to make the charger operate within safe input voltage area.
KEY	16	Press key and battery thermal sense pin. Pull up to BAT with the resistor. Connect to the NTC to achieve battery thermal protection. Disable thermal protection without pull-down resistor



**Absolute Maximum Ratings**

VIN	-0.3-18V
LX, SYS, STAT, IIN, VDPM, CV, ICHG, ISYS, DP, DM, BAT, KEY	-0.3-6V
VIN Pin current continuous	2.5A
SYS Pin current continuous	3.5A
LX Pin current continuous	8A
Power Dissipation, Pd @ TA = 25°C, QFN3x3	2.1W
Package Thermal Resistance	
θJA	48°C/W
θJC	4°C/W
Junction Temperature Range	-40°C to +125°C
Lead Temperature (Soldering, 10 sec.)	260°C
Storage Temperature Range	-65°C to 125°C

**Recommended Operating Conditions**

VIN	0-5.5V
LX, SYS, STAT, IIN, VDPM, CV, ICHG, ISYS, DP, DM, BAT, KEY	0-5.5V
VIN Pin current continuous	2.0A
SYS Pin current continuous	2.5A
LX Pin current continuous	6A
Junction Temperature Range	-20°C to 100°C
Ambient Temperature Range	-40°C to 85°C

Silergy Corp. Confidential-Prepared for JYC



# SY6918

## Electrical Characteristics

$T_J=25^{\circ}\text{C}$ ,  $V_{IN}=5\text{V}$ ,  $C_{IN}=10\mu\text{F}$ ,  $C_{BAT}=10\mu\text{F}$ ,  $C_{SYS}=44\mu\text{F}$ ,  $L=1.5\mu\text{H}$ , unless otherwise specified.

Symbol	Parameter	Conditions	Min	Typ	Max	Unit
<b>Bias Supply (<math>V_{IN}</math>)</b>						
$V_{IN}$	Input voltage operation range		4.5		5.35	V
$V_{INOK}$	Adapter OK voltage	Rising edge	4.35	4.5	4.65	V
$\Delta V_{INOK}$	Adapter OK voltage hysteresis	Falling edge		200		mV
$V_{OVP}$	Input overvoltage protection	Rising edge	5.4	5.55	5.7	V
$\Delta V_{OVP}$	Input overvoltage protection hysteresis	Falling edge		200		mV
$V_{DPM}$	Input voltage REF for adaptive input current limit		1.17	1.2	1.23	V
<b>Quiescent Current</b>						
$I_{BAT}$	Battery discharge current	Boost shutdown, $V_{SYS}>V_{BAT}\times 90\%$ , $V_{KEY}=V_{BAT}$			20	$\mu\text{A}$
$I_{IN}$	Input quiescent current	Disable Charge			1.5	mA
<b>Oscillator and PWM</b>						
$f_{OSC}$	Switching frequency			500		kHz
<b>Power MOSFET</b>						
$R_{HIGH}$	$R_{DS(ON)}$ of High side P-FET	$R_{SH}$		35		m $\Omega$
$R_{LOW}$	$R_{DS(ON)}$ of Low side N-FET	$R_{SL}$		20		m $\Omega$
$R_{PM}$	$R_{DS(ON)}$ of Power Path Management N-FET	$R_{SA}+R_{SB}$		80		m $\Omega$
$I_{CHG\_MAX}$	Peak current of switching FETs on Charge mode			4.5		A
$I_{DIS\_MAX}$	Peak current of switching FETs on Discharge mode			8		A
<b>Voltage Threshold and Regulation</b>						
$V_{CV}$	Cell voltage tolerance	$V_{CV}=4.35\text{V}$	4.324	4.35	4.376	V
$\Delta V_{RCH}$	CV hysteresis for Recharge	$V_{CV}=4.35\text{V}$	50	100	150	mV
$V_{SYS}$	Discharge output voltage at SYS	$V_{BAT}=3.7\text{V}$	5.05	5.15	5.25	V
<b>Current Regulation</b>						
$I_{CC}$	Internal charge current accuracy for Constant Current Mode	$R_{CHG}=2.55\text{k}$ ( $I_{CC}=2\text{A}$ )	-10		10	%
$I_{TC}$	Internal charge current for Trickle Current Mode	$R_{CHG}=2.55\text{k}$ ( $I_{CC}=2\text{A}$ )		0.1		$I_{CC}$
$I_{TERM}$	Termination current	$R_{CHG}=2.55\text{k}$ ( $I_{CC}=2\text{A}$ )		0.1		$I_{CC}$
$I_{INDPM}$	Maximum input current limit when charger is switching.	$R_{IN}=0.78\text{k}$ , $I_{CHG}=1\text{A}$	2.25	2.5	2.75	A
$I_{SYS\_LL}$	SYS current with light Boost load for Boost auto shutdown	$V_{BAT}=3.7\text{V}$ , $R_{SYS}=2.2\text{k}$	25	50	75	mA
<b>System and BAT OVP</b>						
$V_{SYS\_OVP}$	SYS voltage OVP threshold	Rising edge	103%	105%	107%	$V_{SYS}$
$\Delta V_{SYS\_OVP}$	SYS voltage OVP hysteresis	Falling edge		2%		$V_{SYS}$
$V_{BAT\_OVP}$	BAT voltage OVP threshold	Rising edge	103%	105%	107%	$V_{CV}$
$\Delta V_{BAT\_OVP}$	BAT voltage OVP hysteresis	Falling edge		2%		$V_{CV}$
<b>Battery Weak</b>						
$V_{DPL}$	Battery depletion threshold	Falling edge		2.5		V
$\Delta V_{DPL}$	Battery depletion hysteresis	Rising edge		300		mV
$V_{TRK}$	Battery trickle charge threshold	Falling edge	2.5	2.6	2.7	V



$\Delta V_{TRK}$	Battery trickle charge hysteresis	Rising edge		200		mV
<b>BAT Short Protection</b>						
$V_{SHORT}$	Output short protection threshold	$V_{BAT}$ falling edge	1.9	2.0	2.1	V
<b>SYS Over Current Protection</b>						
$I_{SYS MAX}$	SYS current limit on Boost mode	$V_{BAT}=3.7V, R_{SYS}=2.2k$	2.25	2.5	2.75	A
<b>Timing</b>						
$T_{IC}$	Trickle current charge timeout			2		hour
$T_{OC}$	ACOC deglitch time			600		us
$T_{SYS LL}$	SYS light load deglitch time			40		s
<b>Battery Thermal Protection</b>						
$V_{UTP}$	UTP threshold	Rising edge	65.7%	67.7%	69.7%	$V_{BAT}$
	UTP hysteresis	Falling edge		3.5%		$V_{BAT}$
$V_{OTP}$	OTP threshold	Falling edge	29.9%	31.9%	33.9%	$V_{BAT}$
	OTP hysteresis	Rising edge		2%		$V_{BAT}$
$V_{NTCHIGH}$	High voltage to disable NTC function	Rising edge		90%		$V_{BAT}$
$V_{KEY}$	KEY active low voltage	Falling edge		0.35		V
<b>Thermal Regulation and Thermal Shutdown</b>						
$T_{TSD}$	Thermal shutdown threshold			150		°C
$\Delta T_{TSD}$	Thermal shutdown hysteresis			30		°C

**Note 1:** Stresses beyond the “Absolute Maximum Ratings” may cause permanent damage to the device. These are stress ratings only. Functional operation of the device at these or any other conditions beyond those indicated in the operational sections of the specification is not implied. Exposure to absolute maximum rating conditions for extended periods may affect device reliability.

**Note 2:**  $\theta_{JA}$  is measured in the natural convection at  $T_A = 25^\circ C$  on a low effective four-layer thermal conductivity test board of JEDEC 51-3 thermal measurement standard.

**Note 3:** The device is not guaranteed to function outside its operating conditions.

## General Function Description

SY6918 is a 4.5-5.35V  $V_{IN}$  up to 18V  $V_{IN}$  surge bi-directional regulator designed for single cell Li-Ion battery power bank application. Advanced bi-directional energy flow control with automatic input power source detection is adopted to achieve battery charging mode and battery power supply mode alternately. If the external power supply is present, SY6918 runs in battery charging mode with fully protection function. If the external power supply is absent, SY6918 runs in battery power supply mode with output current capability up to 2.5A.

SY6918 has integrated blocking switches to prevent current leaking from the system side or battery side to the input side. The high side switch protects the battery from high discharge current and short circuits at SYS point.

SY6918 also provides the KEY control and LED status indication.

### Press Key Function

Press KEY low can control the Boost. The functions are listed in below table.

1 Short	1 time	Enable Boost
1 Long	>1s	Shutdown Boost

IC will not response to the KEY on action within 1S after the previous KEY action.

KEY pin is also used as battery NTC temperature sensing if the voltage is lower than 90%  $V_{BAT}$ . When KEY voltage is higher than  $V_{UTP}$  or lower than  $V_{OTP}$  (but higher than  $V_{KEY}$ ), IC will shutdown charger and indicate the fault.

### LED Status Indication Description

Connecting a LED to STAT pin can indicate the charging status, discharging status and faults mode.

1. Charging Mode - When the adapter is present, SY6918 works in charging mode even the charging is done. In charging mode, the LED ON indicates the charging ongoing and the LED OFF indicates the charging done.
2. Discharging Mode - When the adapter is removed, and the Boost is enabled, IC works in discharging mode. In discharging mode, the LED ON indicates the discharging ongoing.

3. Fault Mode – When any fault (Input OVP, Battery OVP, SYS OVP, Battery short, NTC faults, thermal shutdown, timeout, SYS short) occurs, the LED flashes with 2Hz.

The detailed LED status description is as follows:

- Charging mode: STAT low
- Charging done: STAT high
- Discharging mode: STAT low
- Fault Mode: 2Hz flash.

### Input Dynamic Power Management

SY6918 can management the input power limit very well. It has input VDPM and IDPM function to protect the input source from high current.

The IC can set the input source power capability in charge mode. The minimum input voltage limit can be set by connecting a resistor divider from  $V_{IN}$  to VDPM pin. The maximum input current limit is determined by the resistor from IIN pin to GND.

The relationship between the input current limit and  $R_{IIN}$  is showed in below curve.

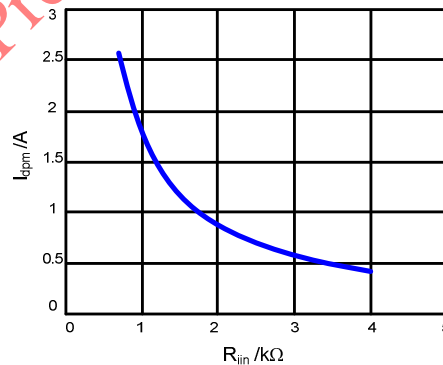

Test condition:  $V_{IN}=5V$ ,  $V_{BAT}=3.7V$

### Charge Current Setting

In the charging mode, SY6918 mirrors the current information to the ICHG pin and the charge current is determined by the resistance from the ICHG pin to GND.

The relationship between the charging current and  $R_{CHG}$  is showed in below curve.

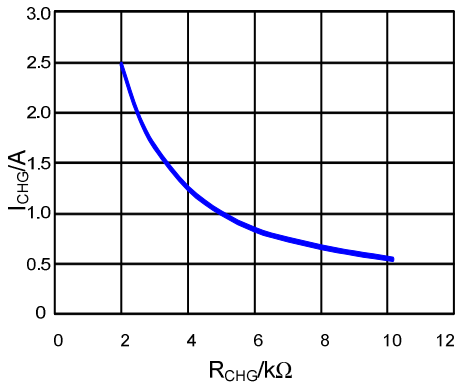

Test condition:  $V_{IN}=5V, V_{BAT}=3.7V$

SY6918 has good  $I_{CHG}$  regulation performance even in wide  $V_{IN}$  and  $V_{BAT}$  range. The relationship between the charging current and  $V_{BAT}$  is showed in below curves.

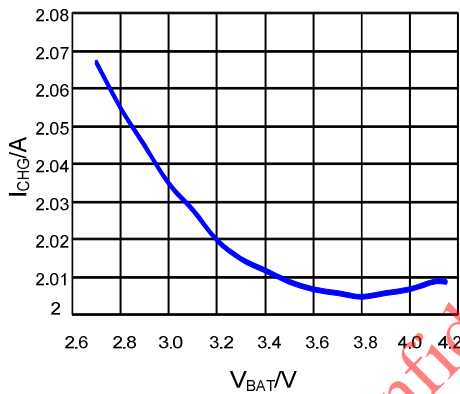

Test condition:  $V_{IN}=5V, R_{CHG}=2.5K$

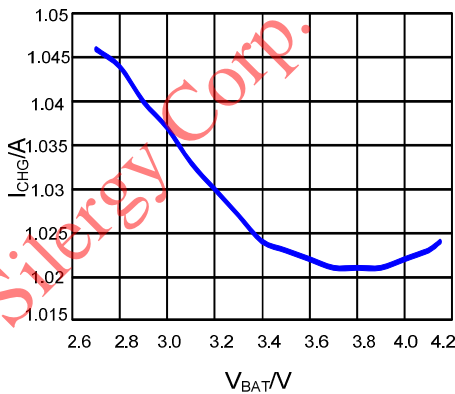

Test condition:  $V_{IN}=5V, R_{CHG}=5K$

The relationship between the charging current and  $V_{IN}$  is showed in below curve.

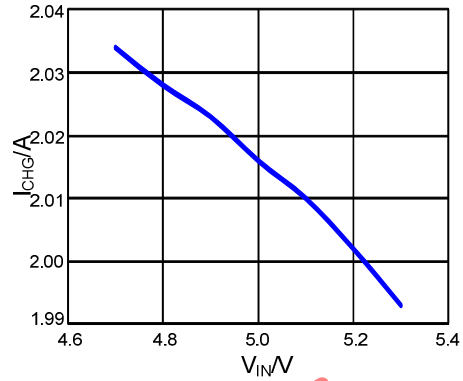

Test condition:  $V_{BAT}=3.7V, R_{CHG}=2.5K$

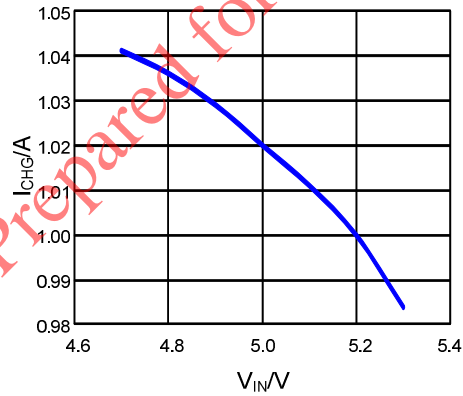

Test condition:  $V_{BAT}=3.7V, R_{CHG}=5K$

## SYS Current Limit Setting

In discharge mode, SY6918 mirrors the current information to the ISYS pin and the discharge current limit is determined by the resistance from the ISYS pin to GND.

The relationship between the discharge current limit and  $R_{SYS}$  is showed in below curve.



# SY6918

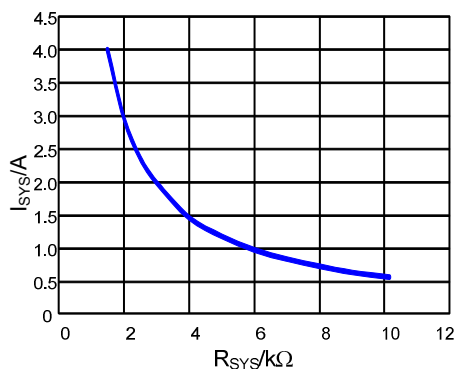

Test condition:  $V_{BAT}=3.7V, V_{SYS}=4.7V$

SY6918 has good  $I_{SYS}$  regulation performance even in wide  $V_{SYS}$  and  $V_{BAT}$  range. The relationship between the discharge current limit and  $V_{SYS}$  is showed in below curves.

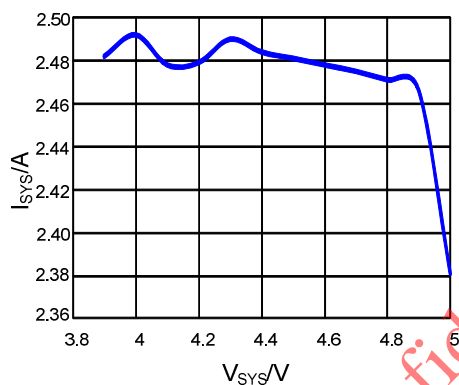

Test condition:  $V_{BAT}=3.7V, R_{SYS}=2.2K$

The relationship between the discharge current limit and  $V_{BAT}$  is showed in below curve.

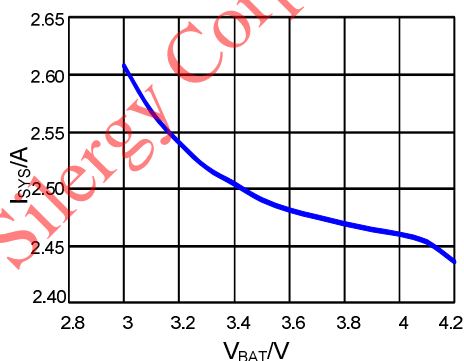

Test condition:  $V_{SYS}=4.7V, R_{SYS}=2.2K$

## Portable Device Insert Detection

When the portable device is removed from SYS connector, SY6918 will charge the SYS high with about 3uA current. The SYS voltage falling edge crossing 1.5V will enable the Boost again.

Lower than 3Mohm resistors connecting to SYS pin may lead SYS voltage can't be charged high than 1.5V. Suggest connecting no resistor at SYS pin.

The external resistor added between BAT and SYS pins can extend the 3uA current.

## Buck Charger Basic Operation Description

SY6918 works as a synchronous Buck mode battery charger when the adapter is present. It utilizes 500KHz switching frequency to minimize the PCB design.

The charger will operates in battery short mode, trickle charge mode, constant current charge mode and constant voltage charge mode according to the battery voltage. The charge current in every mode is showed in below charge curve.

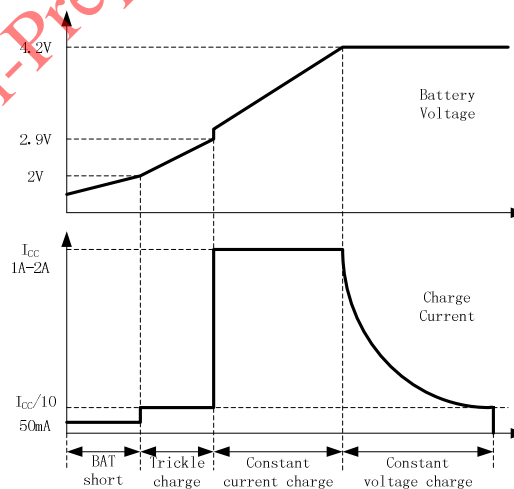

In charge mode, SY6918 has full protection to protect the IC and the battery.

**Input Over Voltage Protection** – SY6918 has both VIN and SYS over voltage protection. It will turn off blocking FETs and switching charger when input OVP occurs. IC will auto recover normal operation when fault removes.

**BAT Over Voltage Protection** – SY6918 will stop charging when BAT OVP occurs. IC will auto recover normal operation when fault removes.





**Timeout Protection** – The charger can detect a bad battery. It will stop charge and latch off when the charger works over 2 hours in trickle mode. Only recycling the input can release this fault.

**Input Over Current Protection** – SY6918 has hiccup mode input over current protection. The threshold is 25% higher than the IDMP value.

### **Boost Mode Basic Operation Description**

The battery can supply the portable device connecting to SYS pin when the adapter is removed. The converter works as a 500KHz synchronous Boost which can deliver up to 2.5A current to the load.

The Boost provides 5.15V for the portable device. It limits the output current which is set by  $R_{SYS}$ .

In Boost mode, SY6918 provides full protections for the portable device, the battery and itself.

**SYS Over Voltage Protection** – SY6918 will stop switching when SYS OVP occurs. IC will auto recover normal operation when fault removes.

**BAT Depletion Protection** – SY6918 will stop operation when BAT depletion occurs. To recover switching, IC needs to be enabled again after fault removes.

### **Common Protection Description**

SY6918 also provides some common protections to prevent all the related devices.

**SYS short Protection** – SY6918 will stop switching and enter into hiccup mode when SYS short occurs.

**Battery Thermal Protection** – When KEY voltage is lower than OTP threshold and higher than 0.35V or higher than UTP threshold and lower than 90%BAT, the converter will stop switching. IC will auto recovery when fault removes.

**Thermal Shutdown Protection** – The IC will stop operation when the junction temperature is higher than 150°C. It will auto recover normal when fault removes.

**Typical Performance Characteristics**

$T_A=25^{\circ}\text{C}$ ,  $V_{IN}=5\text{V}$ ,  $R_{CHG}=2.55\text{k}$ ,  $R_{SYS}=2.2\text{k}$ , 1cell battery, unless otherwise specified.

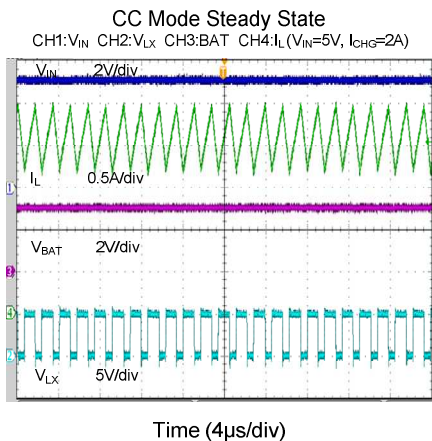
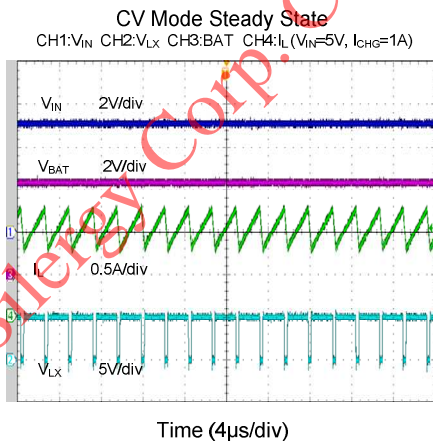
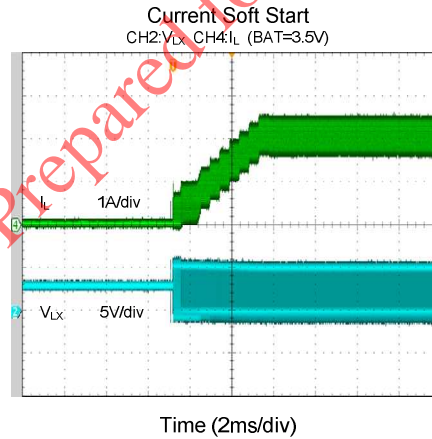
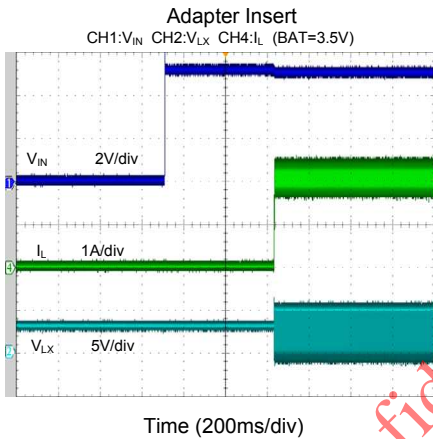
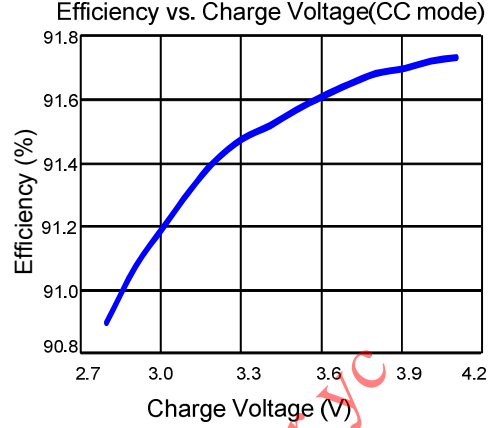
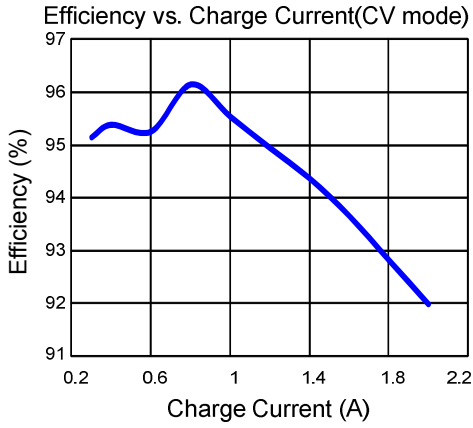

**Boost To Buck Transition**  
CH1:V<sub>IN</sub> CH2:V<sub>LX</sub> CH3:V<sub>BAT</sub> CH4:I<sub>L</sub>

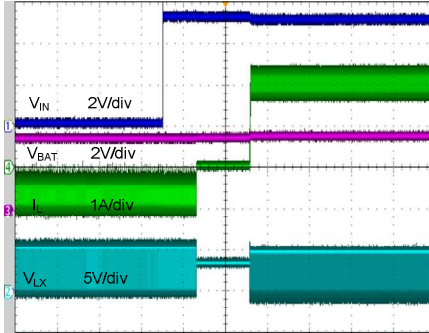

Time (200ms/div)

**Efficiency vs. SYS Current**

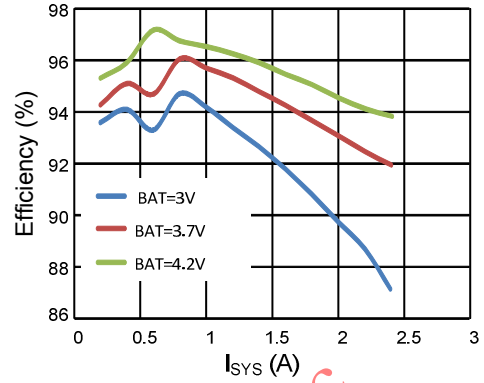

**Press Key To Enable Boost**  
CH1:V<sub>KEY</sub> CH2:V<sub>LX</sub> CH3:V<sub>SYS</sub> CH4:I<sub>L</sub>

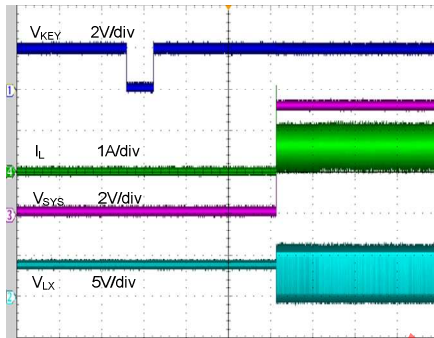

Time (400ms/div)

**Load Insert To Enable Boost**  
CH1:V<sub>BAT</sub> CH2:V<sub>LX</sub> CH3:V<sub>SYS</sub> CH4:I<sub>L</sub>

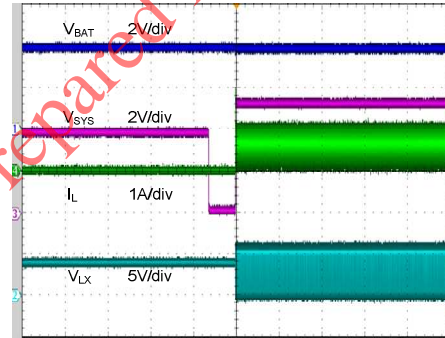

Time (400ms/div)

**Boost Mode Steady State**  
CH2:V<sub>LX</sub> CH3:ΔV<sub>SYS</sub> CH4:I<sub>L</sub>(I<sub>SYS</sub>=0.05A)

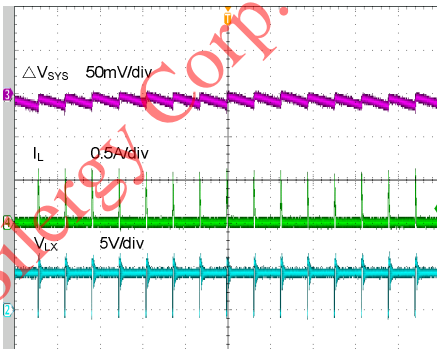

Time (40μs/div)

**Boost Mode Steady State**  
CH2:V<sub>LX</sub> CH3:ΔV<sub>SYS</sub> CH4:I<sub>L</sub>(I<sub>SYS</sub>=2A)

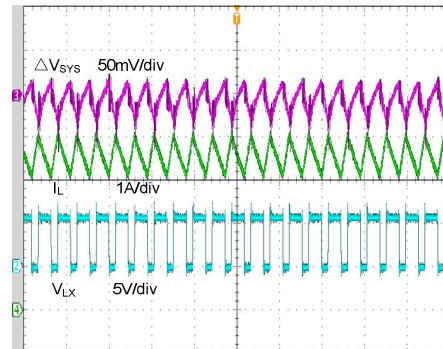

Time (4μs/div)

Boost Light Load Auto Shutdown  
CH1:V<sub>BAT</sub> CH3:V<sub>SYS</sub> CH4:I<sub>L</sub> (I<sub>SYS</sub>=0mA)

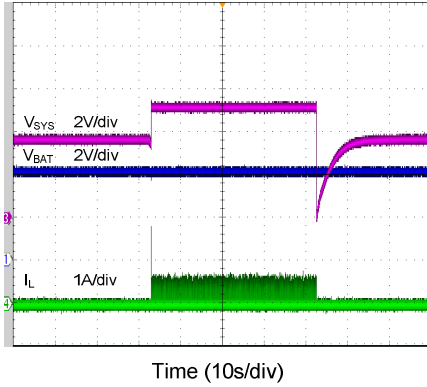

Silergy Corp. Confidential-Prepared for yc

## Applications Information

SY6918 is a very high integration IC for power bank application. The application circuits based on this regulator IC is rather simple. Only filter capacitors ( $C_{IN}$ ,  $C_{BAT}$  and  $C_{SYS}$ ), inductor L, NTC resistors R1, R2 and current setting resistors ( $R_{CHG}$ ,  $R_{SYS}$ ) need to be selected for the targeted applications specifications.

### NTC resistor:

SY6918 monitors battery temperature by measuring the input voltage and NTC voltage. The controller triggers the UTP or OTP when the rate K ( $K = V_{NTC}/V_{BAT}$ ) reaches the threshold of UTP ( $K_{UT}$ ) or OTP ( $K_{OT}$ ). The temperature sensing network is showed as below.

Choose R1 and R2 to program the proper UTP and OTP points.

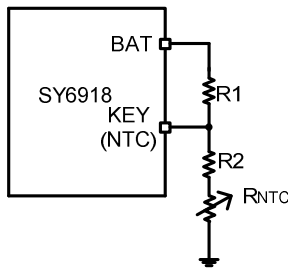

The calculation steps are:

1. Define  $K_{UT}$ ,  $K_{UT} = 65.7\sim 69.7\%$
2. Define  $K_{OT}$ ,  $K_{OT} = 29.9\sim 33.9\%$
3. Assume the resistance of the battery NTC thermistor is  $R_{UT}$  at UTP threshold and  $R_{OT}$  at OTP threshold.
4. Calculate R2,

$$R2 = \frac{K_{OT}(1 - K_{UT})R_{OT} - K_{UT}(1 - K_{OT})R_{OT}}{K_{UT} - K_{OT}}$$

5. Calculate R1

$$R1 = (1/K_{OT} - 1)(R2 + R_{OT})$$

If choose the typical values  $K_{UT} = 67.7\%$  and  $K_{OT} = 31.9\%$ , then

$$R2 = 0.288R_{UT} - 1.288R_{OT}$$

$$R1 = 2.135(R2 + R_{OT})$$

SY6918 accepts various NTC divider circuits. For below method, R1 and R2 can be calculated by below equations.

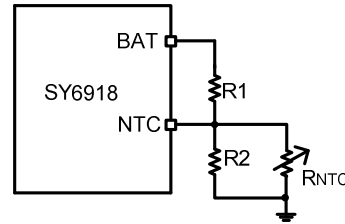

$$R2 = \frac{R_{OT}R_{UT}(K_{UT} - K_{OT})}{K_{OT}K_{UT}(R_{UT} - R_{OT}) + R_{UT}K_{OT} - R_{OT}K_{UT}}$$

$$R1 = \frac{R2R_{UT}(1 - K_{UT})}{K_{UT}(R2 + R_{UT})}$$

If choose the typical values  $K_{UT} = 67.7\%$  and  $K_{OT} = 31.9\%$ , then

$$R2 = \frac{0.358R_{UT}R_{OT}}{0.103R_{UT} - 0.461R_{OT}}$$

$$R1 = \frac{0.477R2R_{UT}}{R_{UT} + R2}$$

### Input capacitor $C_{IN}$ :

X5R or X7R ceramic capacitors with greater than 10uF capacitance are recommended to handle this ripple current. The voltage rating of the output capacitor should be higher than 16V.

### Output capacitor $C_{BAT}$ :

The charger output capacitor is selected to handle the output ripple noise requirements. This ripple voltage is related to the capacitance and its equivalent series resistance (ESR). For the best performance, it is recommended to use X5R or better grade low ESR ceramic capacitor. The voltage rating of the output capacitor should be higher than 10V.

To design a smaller output ripple, greater than 10uF capacitance is recommended.

### Output capacitor $C_{SYS}$ :

The boost output capacitor is selected to handle the output ripple noise and out load transient requirements. For the best performance, it is recommended to use X5R or better grade low ESR ceramic capacitor. The voltage rating of the output capacitor should be higher than 10V.

To design a smaller output ripple and better transient performance, greater than 2pcs of 22uF capacitance is recommended.

## Inductor L:

There are several considerations in choosing this inductor.

- 1) Choose the inductance to provide the desired ripple current. It is suggested to choose the ripple current to be about 40% of the average input current. The Boost inductor current is worse than the charger mode, so we choose the inductor based on Boost mode. The inductance is calculated as:

$$L = \left( \frac{V_{BAT}}{V_{SYS}} \right)^2 \frac{V_{SYS} - V_{BAT}}{I_{SYS} \cdot F_{SW} \cdot 40\%}$$

Where  $F_{SW}$  is the switching frequency and  $I_{SYS}$  is the setting discharge current.

The SY6918 is quite tolerant of different ripple current amplitude. Consequently, the final choice of inductance can be slightly off the calculation value without significantly impacting the performance.

Recommend the 1.5uH inductance in SY6918 applications.

- 2) The saturation current rating of the inductor must be selected to be greater than the peak inductor current under full load conditions.

$$I_{SAT} > \frac{V_{SYS} \cdot I_{SYS}}{V_{BAT}} + \left( \frac{V_{BAT}}{V_{SYS}} \right) \frac{V_{SYS} - V_{BAT}}{2 \cdot F_{SW} \cdot L}$$

- 3) The DCR of the inductor and the core loss at the switching frequency must be low enough to achieve the desired efficiency requirement. It is desirable to choose an inductor with  $DCR < 10\text{mohm}$  to achieve a good overall efficiency.

## Layout Design:

The layout design of SY6918 regulator is relatively simple. For the best efficiency and minimum noise problems, we should place the following components close to the IC:  $C_{IN}$ , L,  $C_{SYS}$ , especially  $C_{SYS}$ .

- 1) The loop of main MOSFET, rectifier MOSFET, and  $C_{SYS}$  must be as short as possible.

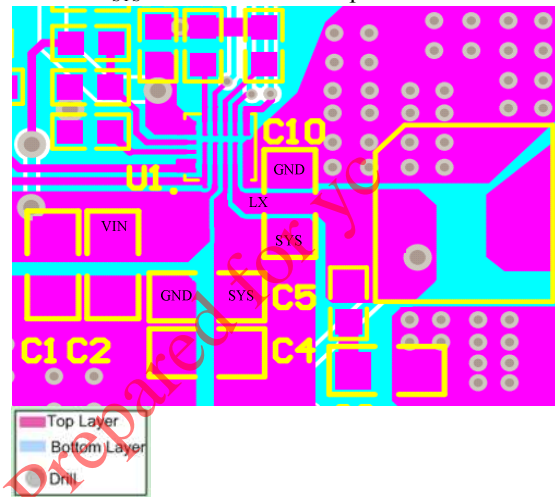

- 2) It is desirable to maximize the PCB copper area connecting to GND pin to achieve the best thermal and noise performance.

- 3)  $C_{IN}$  must be close to pin VIN and GND.

- 4) The PCB copper area associated with LX pin must be minimized to avoid the potential noise problem.

- 5) The small signal component RCHG, RSYS must be placed close to IC and must not be adjacent to the LX net on the PCB layout to avoid the noise problem.

## QFN3x3-16 Package Outline Drawing

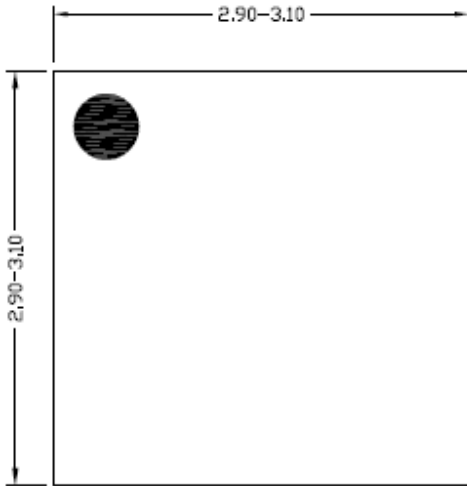

**Top View**

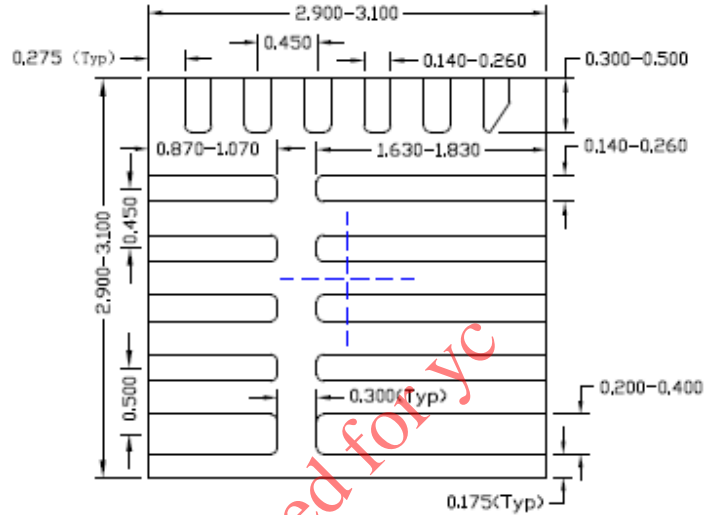

**Bottom View**

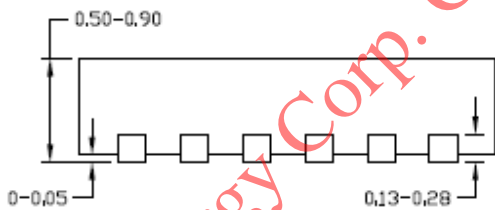

**Side View**

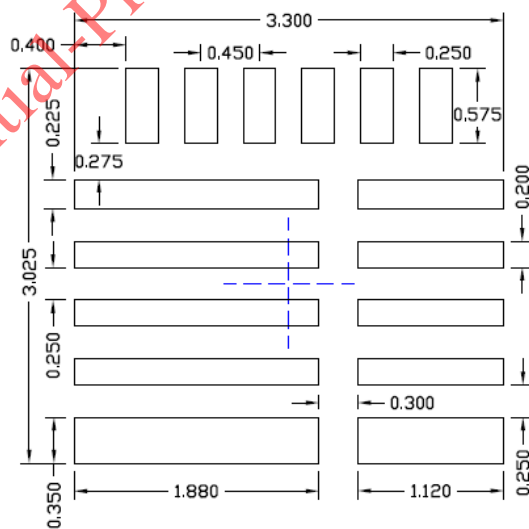

**Recommended PCB layout  
(Reference Only)**

**Notes:** All dimension in millimeter and exclude mold flash & metal burr

**Taping & Reel Specification**

**1. Taping orientation**

QFN3x3

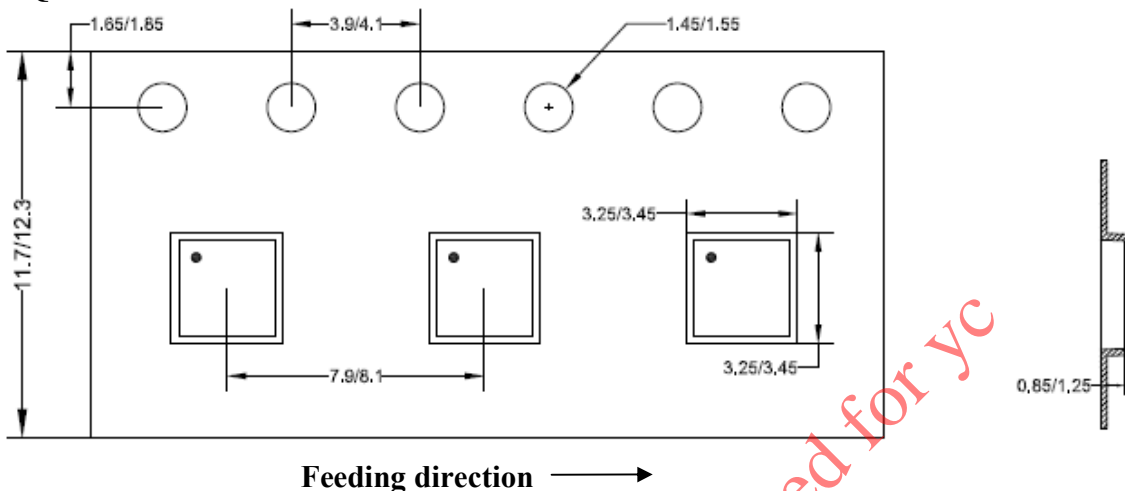

**2. Carrier Tape & Reel specification for packages**

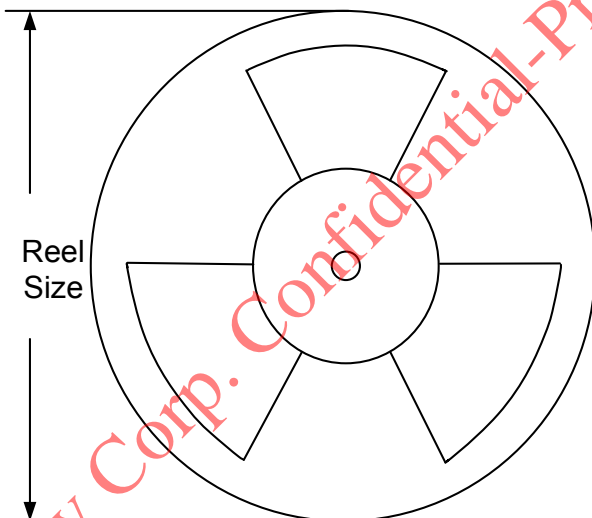

Package types	Tape width (mm)	Pocket pitch(mm)	Reel size (Inch)	Trailer length(mm)	Leader length (mm)	Qty per reel
QFN3x3	12	8	13"	400	400	5000

**3. Others: NA**