

GENERAL DESCRIPTION

The ST53xx series is a high accuracy, high input voltage low quiescent current, high speed, and low dropout liner regulator with high ripple rejection.

The input voltage is up to 40V and load current is up to 300mA at $V_{OUT} = 5V$ & $V_{IN} = 7V$. The device is manufactured with BCD process. The ST53xx offers over-current limit, soft start and over temperature protection to ensure the device working in well conditions.

The ST53xx regulators is available in standard SOT89-3L, SOT23-5L and SOT23-3L packages. Standard products are Pb-free and Halogen-free.

FEATURES

- Input voltage: 4.75V~40V
- Output voltage: 1.8V~5.7V
- Output accuracy: $< \pm 2\%$
- Output current: 150mA (Typ.)
Up to 300mA @ $V_{IN} = 7V$, $V_{OUT} = 5V$, ST53xxT3A package
- PSRR: 60dB @ 100Hz
- Dropout voltage: 600mV @ $I_{OUT} = 100mA$
- Quiescent current: 4.2 μ A @ $V_{IN} = 12V$ (Typ.)
- ESD HBM: 8KV
- Recommend capacitor: 10 μ F

APPLICATIONS

- Smart electric meter
- In-car entertainment
- Electric bicycle

TYPICAL APPLICATION CIRCUIT

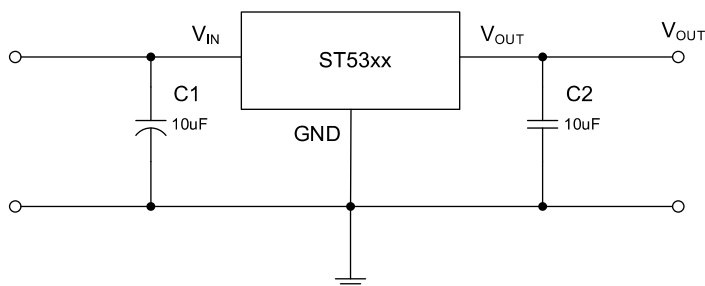

In plugging application, C_{IN} is recommended to use 10 μ F electrolytic capacitor or 10 μ F MLCC with 2 ohm series resistors to prevent chip burning due to the large input voltage spike when plugging. See APPLICATION INFORMATION for more information.

PIN ASSIGNMENT

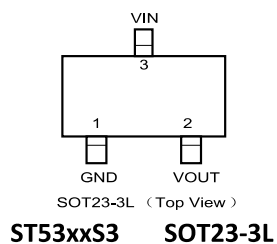
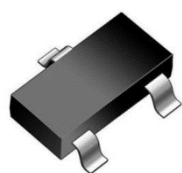
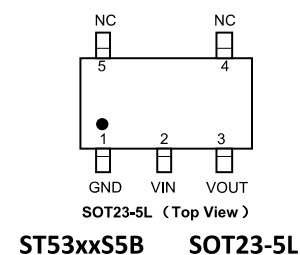
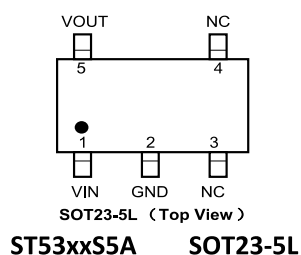
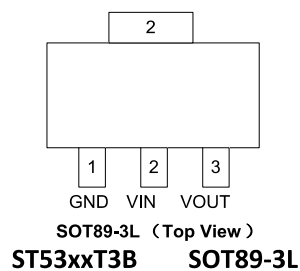
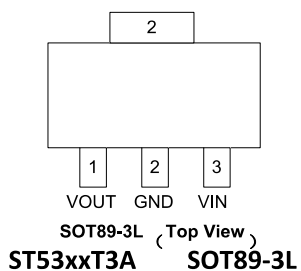

PIN DESCRIPTION

PIN NO	SYMBOL	I/O	DESCRIPTION
ST53xxT3A			
1	VOUT	O	Output
2	GND	Ground	Ground
3	VIN	Power	Input

PIN NO	SYMBOL	I/O	DESCRIPTION
ST53xxT3B			
1	GND	Ground	Ground
2	VIN	Power	Input
3	VOUT	O	Output

PIN NO	SYMBOL	I/O	DESCRIPTION
ST53xxS5A			
1	VIN	Power	Input
2	GND	Ground	Ground
3	NC	-	Not connect
4	NC	-	Not connect
5	VOUT	O	Output

PIN NO	SYMBOL	I/O	DESCRIPTION
ST53xxS5B			
1	GND	Ground	Ground
2	VIN	Power	Input
3	VOUT	O	Output
4	NC	-	Not connect
5	NC	-	Not connect

PIN NO	SYMBOL	I/O	DESCRIPTION
ST53xxS3			
1	GND	Ground	Ground
2	VOUT	O	Output
3	VIN	Power	Input

ORDERING INFORMATION

PART NO	PACAKGE	TEMPERATURE	TAPE & REEL
ST53xxT3A-XX	SOT89-3L	-40 ~ +105 °C	2500/REEL
ST53xxT3B-XX	SOT89-3L	-40 ~ +105 °C	2500/REEL
ST53xxS5A-XX	SOT23-5L	-40 ~ +105 °C	3000/REEL
ST53xxS5B-XX	SOT23-5L	-40 ~ +105 °C	3000/REEL
ST53xxS3-XX	SOT23-3L	-40 ~ +105 °C	3000/REEL

"XX": several fixed output voltages ranging from 1.8V to 5.7V. E.g. "33": $V_{OUT} = 3.3V$

TYPICAL OUTPUT VOLTAGE CODE TABLE

V _{OUT}	CODE	V _{OUT}	CODE
3.0V	G	3.3V	H
3.6V	I	5.0V	K

ABSOLUTE MAXIMUM RATINGS (Note)

SYMBOL	ITEMS	VALUE	UNIT
V _{IN}	Input Voltage	-0.3~40	V
V _{OUT}	Output Voltage	-0.3~6.5	V
P _{DMAX}	Power Dissipation	OTP limited	W
T _J	Junction Temperature	-40~150	°C
T _{stg}	Storage Temperature	-55 to 150	°C
T _{solder}	Package Lead Soldering Temperature (10s)	260	°C
ESD MM	Machine Mode	200	V
ESD HBM	Human Body Mode	8000	V

Note: Exceed these limits to damage to the device. Exposure to absolute maximum rating conditions may affect device reliability.

RECOMMENDED OPERATING RANGE

SYMBOL	ITEMS	VALUE	UNIT
V _{IN}	V _{IN} Supply Voltage	4.75 to 40	V
R _{θJA}	Thermal Resistance on PCB	45	°C/W
T _{OPT}	Operating Temperature	-40 to +105	°C

SIMPLIFIED BLOCK DIAGRAM

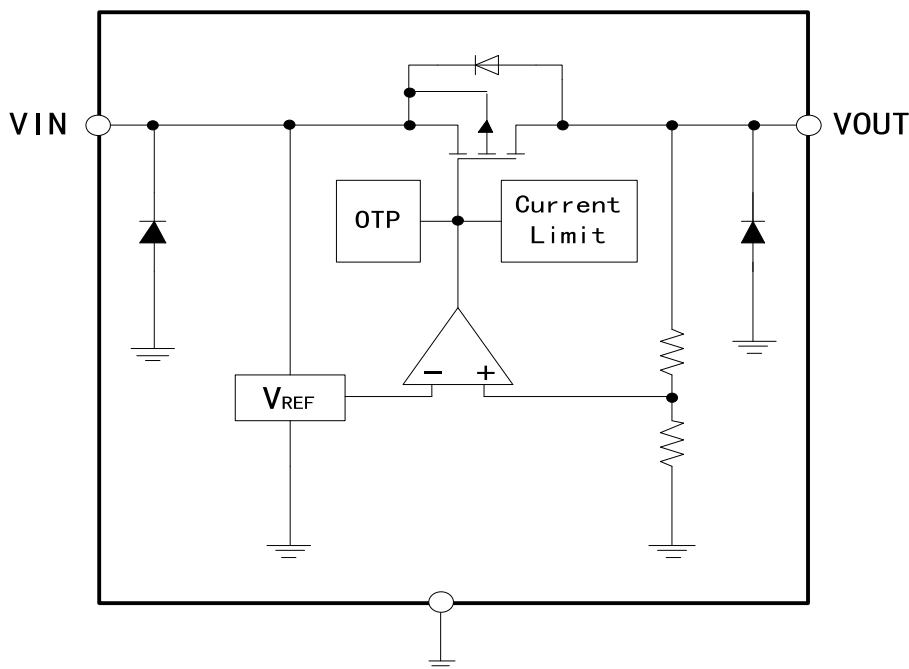

ELECTRICAL CHARACTERISTICS

The following specifications apply for $V_{IN} = 12V$, $T_A = 25^\circ C$, $C_{IN} = C_{OUT} = 10\mu F$, unless specified otherwise.

SYMBOL	ITEMS	CONDITIONS	MIN	TYP	MAX	UNIT
V_{IN}	Input Range	$I_{OUT} = 10mA$	4.75		40	V
V_{OUT}	Output Range	$I_{OUT} = 10mA$	$V_{OUT} \times 0.98$	V_{OUT}	$V_{OUT} \times 1.02$	V
ΔV_{OUT}	Output Voltage	$V_{IN} = 12V, I_{OUT} = 10mA$	4.9	5	5.1	V
			3.234	3.3	3.366	
			2.94	3.0	3.06	
I_Q	Quiescent Current	$V_{IN} = 7V, I_{OUT} = 0$		4	6	μA
		$V_{IN} = 24V, I_{OUT} = 0$		4.6	6.7	
		$V_{IN} = 40V, I_{OUT} = 0$		5.4	8.2	
I_{OUT_PK}	Maximum Output Current	$V_{IN} - V_{OUT} = 4V, R_L = 1\Omega$		500	550	mA
V_{DROP}	Dropout Voltage	$I_{OUT} = 10mA$		60	90	mV
		$I_{OUT} = 100mA$		600	900	
ΔV_{LINE}	Line Regulation	$V_{IN} = 7 \sim 24V, V_{OUT} = 5V, I_{OUT} = 1mA$		0.02	0.03	% / V
		$V_{IN} = 7 \sim 45V, V_{OUT} = 5V, I_{OUT} = 1mA$		0.08	0.1	
ΔV_{LOAD}	Load Regulation	$V_{IN} = 7V, I_{OUT} = 1 \sim 100mA$		19	37	mV
I_{SHORT}	Short Current	V_{OUT} Short to GND with 1Ω (1ms pulse), $V_{IN} = 12V$		180		mA
PSRR	Power Supply Rejection Rate	$V_{IN} = 10V,$ $V_{PP} = 0.5V,$ $I_{OUT} = 1mA$	$F = 100Hz$		60	dB
			$F = 1kHz$		50	
			$F = 10kHz$		40	
e_{NO}	Output Noise Voltage	10Hz to 100kHz, $C_{OUT} = 10\mu F,$ $I_{OUT} = 10mA$		± 100		μV_{RMS}
T_{SD}	Thermal Shutdown Protection	$V_{IN} = 12V, I_{OUT} = 1mA$		165		$^\circ C$
$\Delta V_O / \Delta T$	Temperature Coefficient			± 0.5		mV / $^\circ C$

TYPICAL PERFORMANCE CHARACTERISTICS

$C_{IN} = 10\mu F$, $C_{OUT} = 10\mu F$, $T_{OPT} = 25^{\circ}C$, unless specified otherwise. (ST53xxT3A Package)

IQ vs. Input Voltage

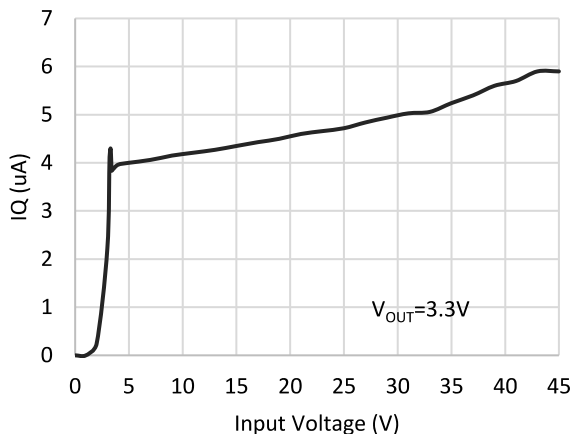

IQ vs. Input Voltage

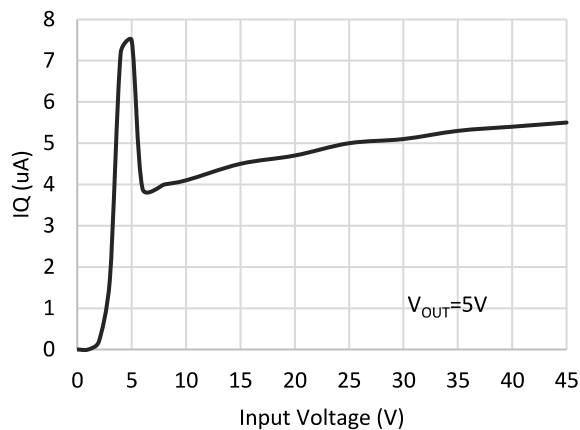

Output Voltage vs. Temperature

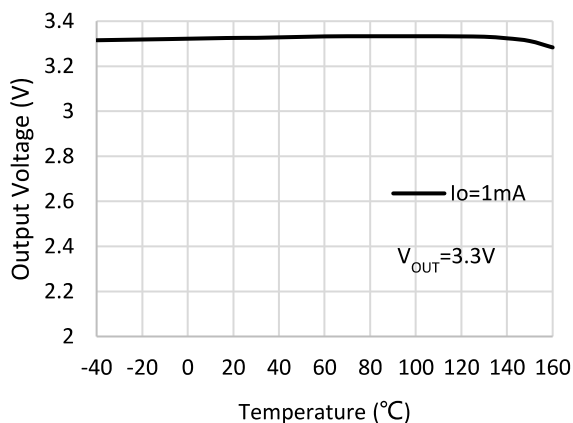

Output Voltage vs. Temperature

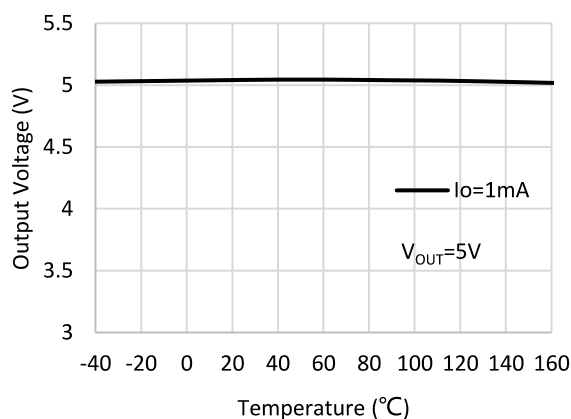

Output Voltage vs. Input Voltage

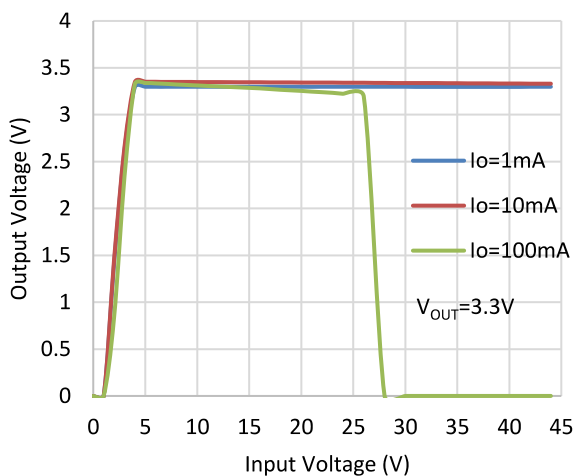

Output Voltage vs. Input Voltage

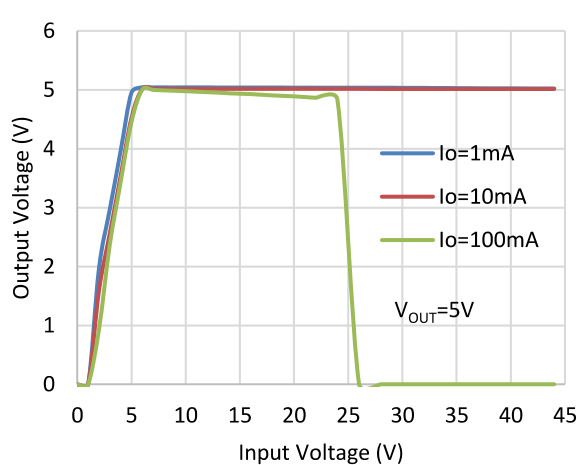

Output Voltage vs. Output Current

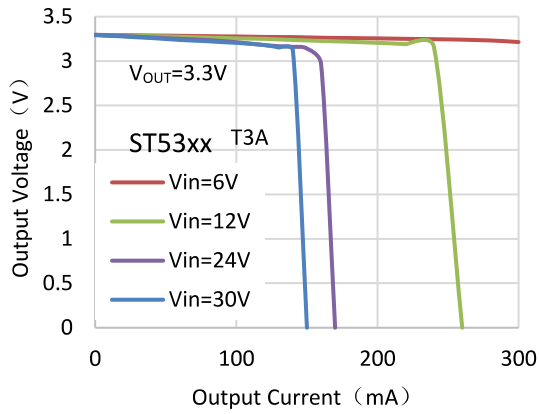

Output Voltage vs. Output Current

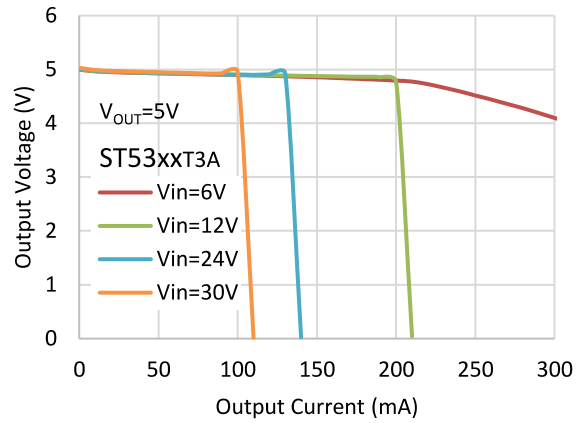

Output Voltage vs. Output Current

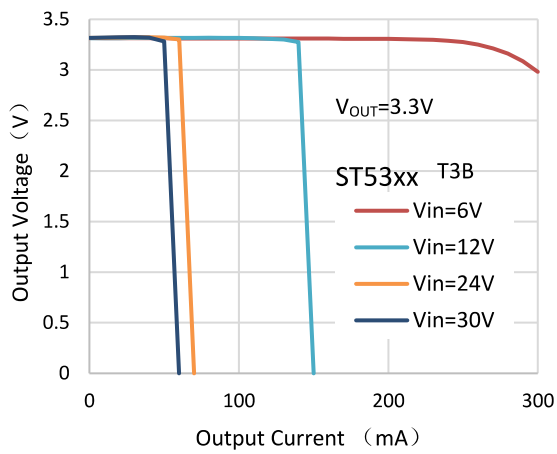

Output Voltage vs. Output Current

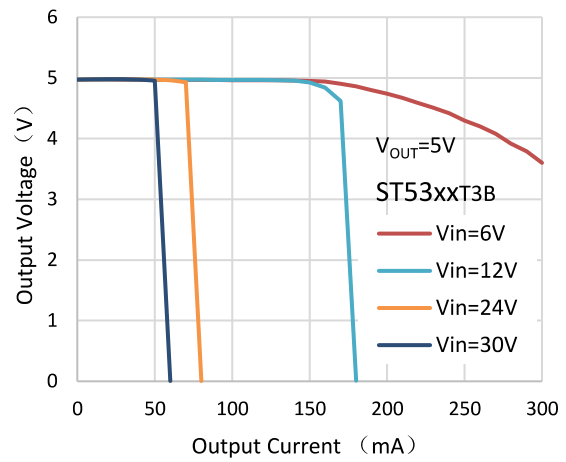

Output Voltage vs. Output Current

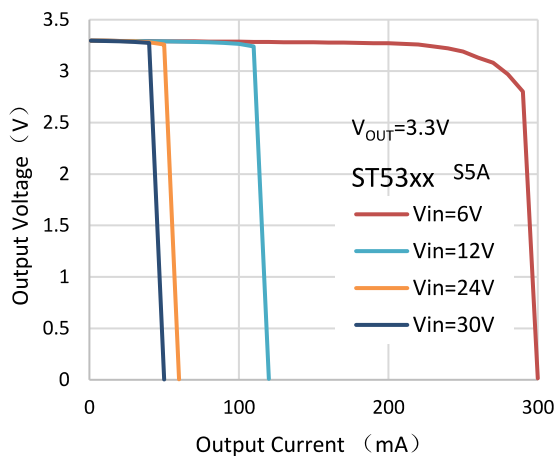

Output Voltage vs. Output Current

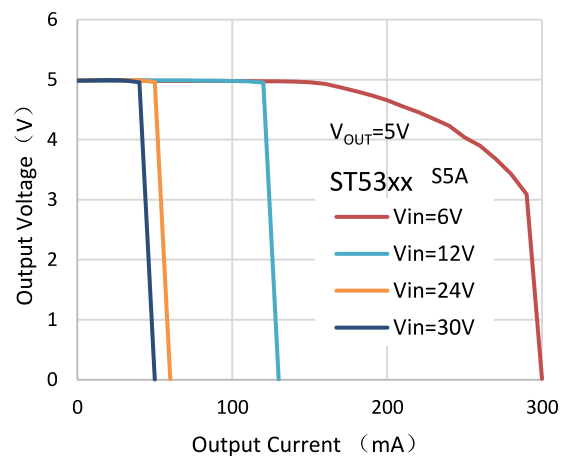

Output Voltage vs. Output Current

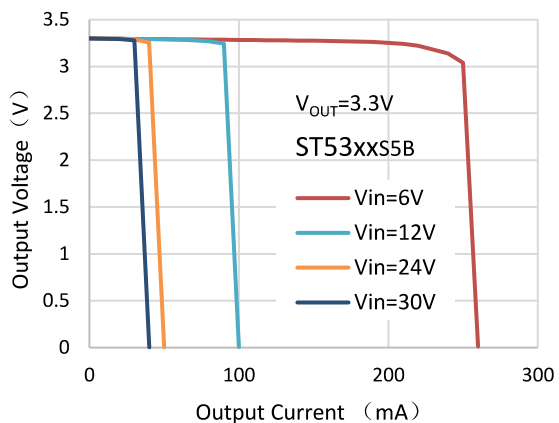

Output Voltage vs. Output Current

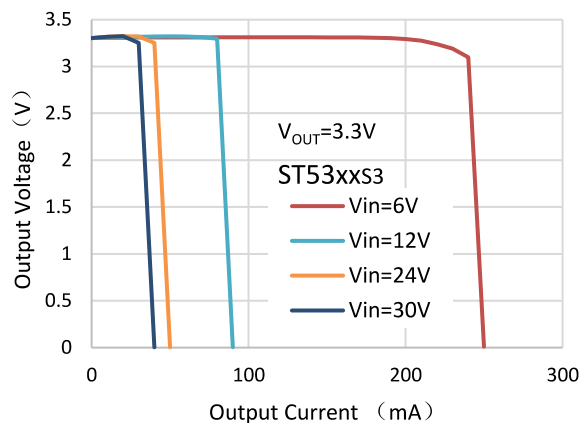

PSRR vs. Frequency

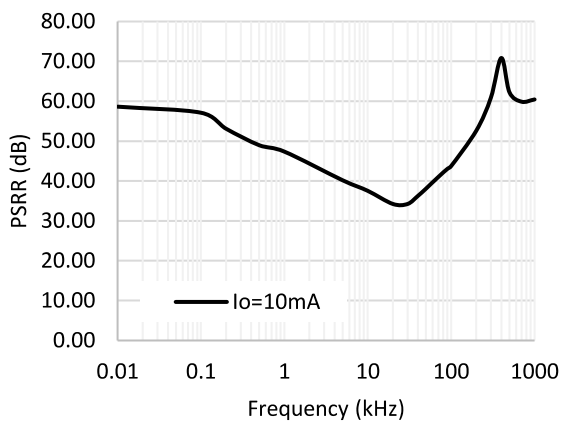

Dropout Voltage vs. Output Current

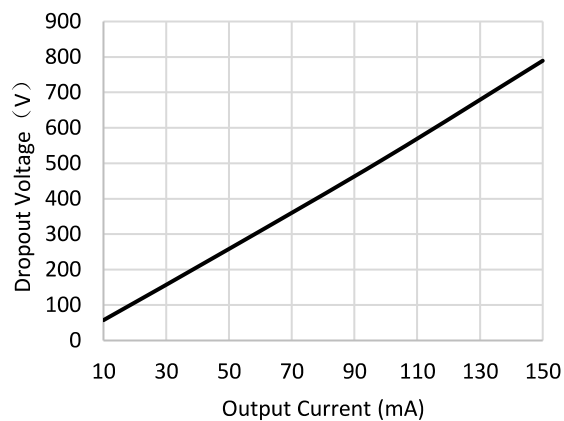

IQ vs. Output current

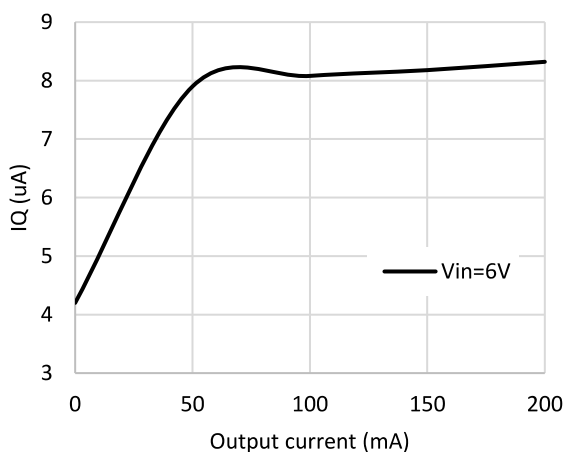

IQ vs. Temperature

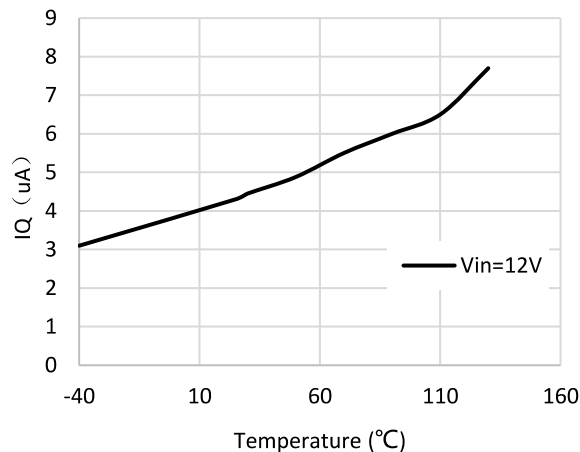

IQ vs. IOU

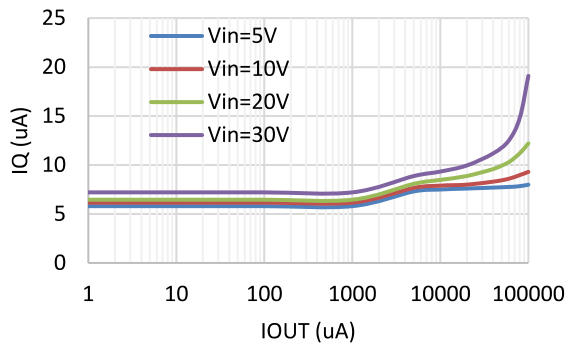

Power ON/OFF

CH1: V_{IN}

CH2: V_{OUT}

$V_{IN}=40\text{V}$

$I_{OUT}=1\text{mA}$

$V_{OUT}=5\text{V}$

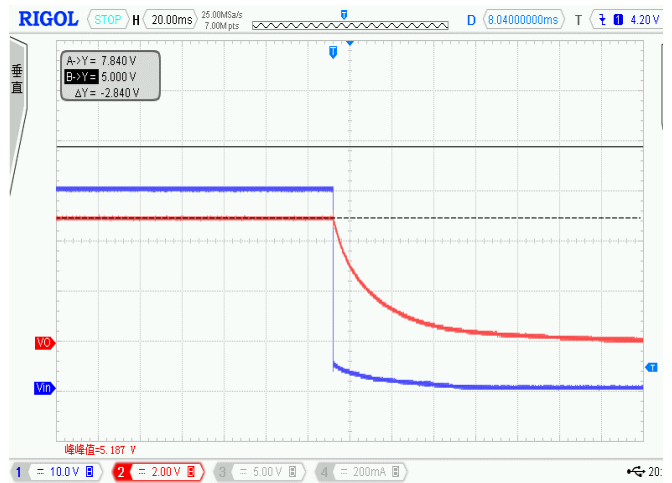

Line Transient

CH1: V_{IN}

CH2: V_{OUT}

$V_{IN}=6\text{V}-12\text{V}$

$I_{OUT}=1\text{mA}$

$V_{OUT}=5\text{V}$

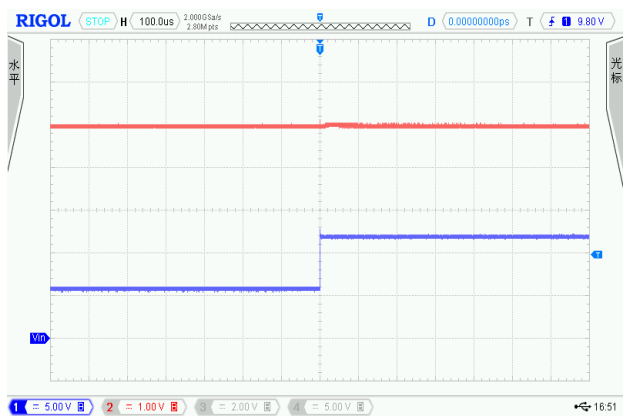

$V_{IN}=6\text{V}-12\text{V}$

$I_{OUT}=10\text{mA}$

$V_{OUT}=5\text{V}$

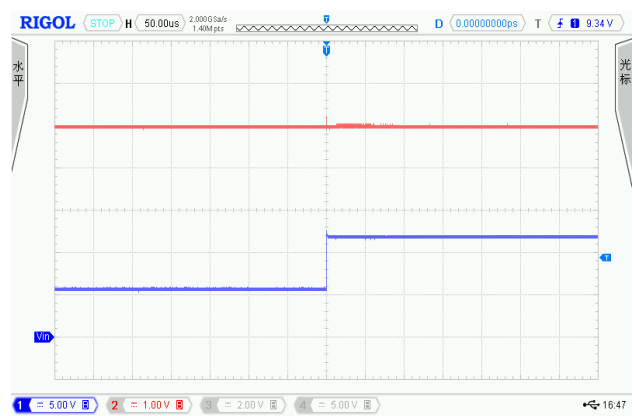

APPLICATION INFORMATION

INPUT CAPACITOR

An input capacitor of $10\mu\text{F}$ is required between the VIN and GND pin. The capacitor shall be placed as close as possible to VIN pin, and the use of electrolytic capacitors is recommended. The tolerance and temperature coefficient must be considered in order to ensure the capacitor work within the operation range over the full range of temperature and operating conditions.

OUTPUT CAPACITOR

In applications, it is important to select the output capacitor for stable operation. The minimum capacitance for stable and correct operation is $1\mu\text{F}$. The capacitance tolerance should be $\pm 30\%$ or better over the operation temperature range. The recommended capacitor type is MLCC.

NO-LOAD STABILITY

The ST53xx will remain stable and in regulation with no external load. This is especially important in CMOS RAM keep-alive applications.

TYPICAL CIRCUIT

The following figure shows a typical application circuit for the ST53xx devices. The value of external components shall be chosen carefully, depending on the application. In plugging application, because the overshoot caused by the insertion and withdrawal of power on the chip may damage the chip, it is recommended that VIN be less than 30V and the input voltage spike should not exceed 45V.

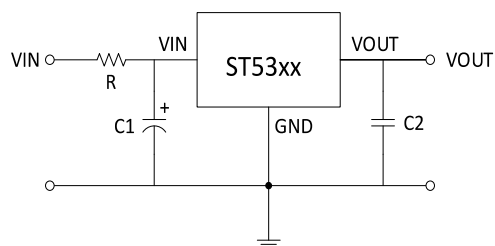

In plugging application, it is suggested that R, C1 are selected as following:

1. $C1=10\mu\text{F} \sim 100\mu\text{F}$ electrolytic capacitor with maximum voltage greater than 50V, $R=0$
2. $C1=1\mu\text{F} \sim 10\mu\text{F}$ MLCC with maximum voltage greater than 50V and $R=2\Omega$ in the type of 1206 - the resistor shall be carefully chosen to make sure enough margin to sustain the surge current during plugging.

PACKAGE OUTLINE

Package	SOT89-3L	Devices per reel	1000Pcs	Unit	mm
Package Dimension:					
Symbol	Dimensions In Millimeters		Dimensions In Inches		
	Min	Max	Min	Max	
A	1.400	1.600	0.055	0.063	
b	0.320	0.520	0.013	0.020	
b1	0.400	0.580	0.016	0.023	
c	0.350	0.440	0.014	0.017	
D	4.400	4.600	0.173	0.181	
D1	1.45	1.65	0.057	0.065	
E	2.300	2.600	0.091	0.102	
E1	3.940	4.250	0.155	0.167	
e	1.500 TYP		0.060 TYP		
e1	3.000 TYP		0.118 TYP		
L	0.900	1.200	0.035	0.047	

PACKAGE OUTLINE

Package	SOT23-5L	Devices per reel	3000Pcs	Unit	mm
Package Dimension:					
Symbol	Dimensions In Millimeters		Dimensions In Inches		
	Min	Max	Min	Max	
A	1.050	1.250	0.041	0.049	
A1	0.000	0.100	0.000	0.004	
A2	1.050	1.150	0.041	0.045	
b	0.300	0.500	0.012	0.020	
c	0.100	0.200	0.004	0.008	
D	2.820	3.020	0.111	0.119	
E	1.500	1.700	0.059	0.067	
E1	2.650	2.950	0.104	0.116	
e	0.950(BSC)		0.037(BSC)		
e1	1.800	2.000	0.071	0.079	
L	0.300	0.600	0.012	0.024	
θ	0°C	8°C	0°C	8°C	

PACKAGE OUTLINE

Package	SOT23-3L	Devices per reel	3000Pcs	Unit	mm
Package Dimension:					
Symbol	Dimensions In Millimeters		Dimensions In Inches		
	Min	Max	Min	Max	
A	1.050	1.250	0.041	0.049	
A1	0.000	0.100	0.000	0.004	
A2	1.050	1.150	0.041	0.045	
b	0.300	0.500	0.012	0.020	
c	0.100	0.200	0.004	0.008	
D	2.820	3.020	0.111	0.119	
E	1.500	1.700	0.059	0.067	
E1	2.650	2.950	0.104	0.116	
e	0.950(BSC)		0.037(BSC)		
e1	1.800	2.000	0.071	0.079	
L	0.300	0.600	0.012	0.024	
θ	0°C	8°C	0°C	8°C	